



fan data

25.11.2024

version FANselect V 1.01 (241125), AMCA V 1.03 September, 2021
RLT V 1.00 Dezember, 2021 / 1.24.11.25 | 30813 | (user ZAFS20813)



type	FN080-SDQ.6N.V7
article no.	154474 Portfolio STD-WW

technical data

motor		AC
mains supply	-	3~ 400V 50Hz D
nominal current (I_N)	A	3.60
ambient temperature, max. limit (t_r)	°C	70
efficiency grade η_{statA}	%	36,0
efficiency grade N_{actual} N_{target}		40,9 40
ErP-conformity		2015
grille influence		pressure side not measured

fan data

frequency (f_{DP}) (f_{max})	Hz	50 60
dimensions (w x h x d)	mm	970 x 970 x 280
product weight (m_{pr})	kg	50.9

PF:PF_50; Type:FN080-SDQ; STol:±10 %

FANselect



performance curve / acoustics

25.11.2024

Version FANselect V 1.01 (241125), AMCA V 1.03 September, 2021
RLT V 1.00 Dezember, 2021 / 1.24.11.25 | 30813 | (user ZAFS20813)

1 FN080-SDQ.6N.V7

Measured in full nozzle without guard grille in air flow direction V in installation type A according to ISO5801

154474 | Portfolio STD-WW measurement density 1.17 [kg/m³]

air performance p_{sF}

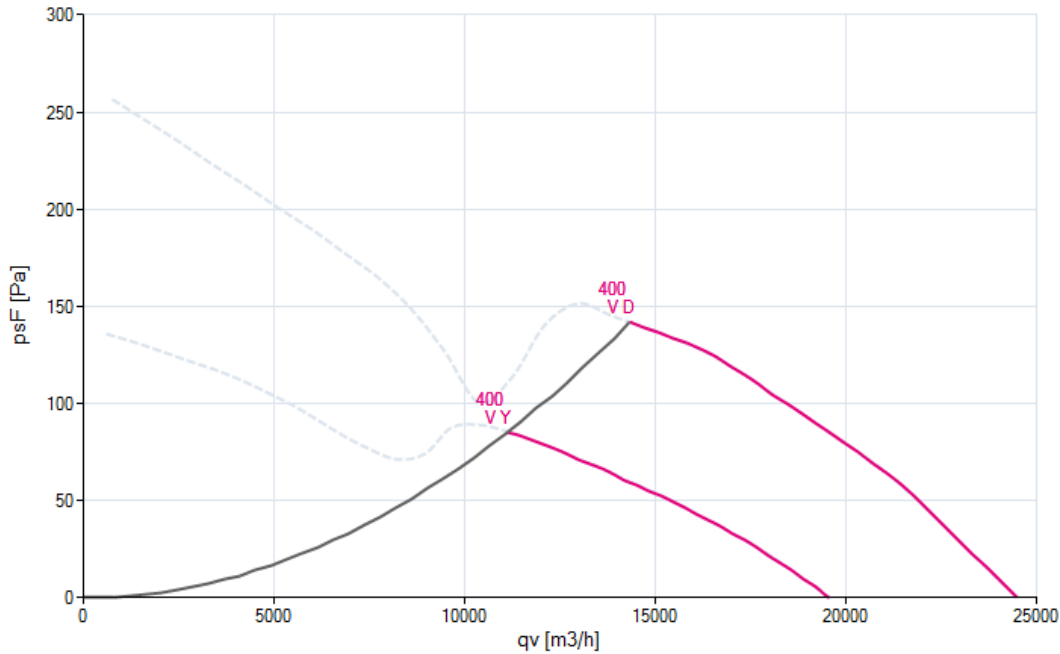

acoustics ($L_{w(A),5}$)

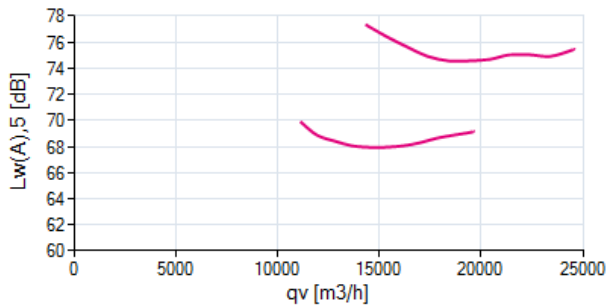

acoustics ($L_{w(A),6}$)

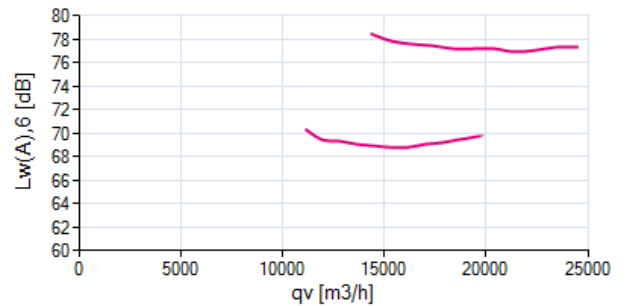

1 FN080-SDQ.6N.V7

f [Hz]	sum	63	125	250	500	1000	2000	4000	8000
$L_{w(A),5}$	-	-	-	-	-	-	-	-	-
$L_{w,5}$	-	-	-	-	-	-	-	-	-

f [Hz]	sum	63	125	250	500	1000	2000	4000	8000
$L_{w(A),6}$	-	-	-	-	-	-	-	-	-
$L_{w,6}$	-	-	-	-	-	-	-	-	-

FANselect



efficiency grade / power input

25.11.2024

Version FANselect V 1.01 (241125), AMCA V 1.03 September, 2021
 RLT V 1.00 Dezember, 2021 / 1.24.11.25 | 30813 | (user ZAFS20813)

1

FN080-SDQ.6N.V7

Measured in full nozzle without guard grille in air flow direction V in installation type A according to ISO5801

154474 | Portfolio STD-WW

measurement density 1.17 [kg/m³]

efficiency grade η_F

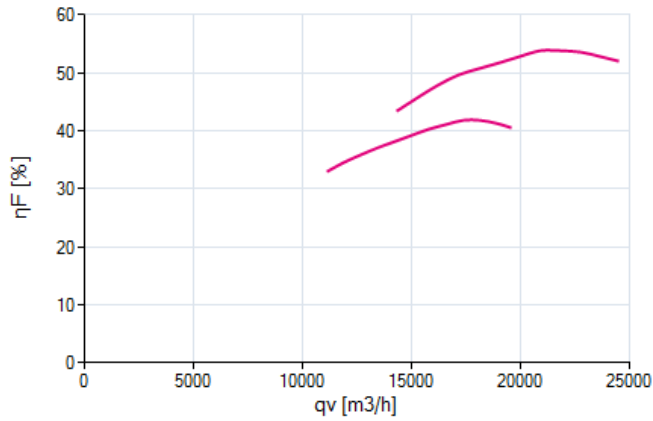

efficiency grade η_{sF}

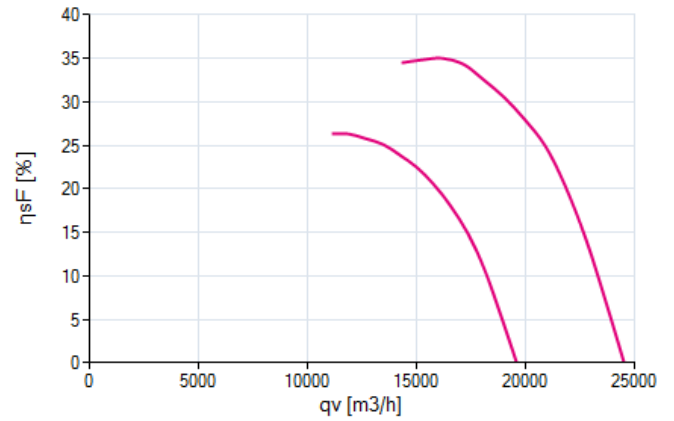

power input P_1

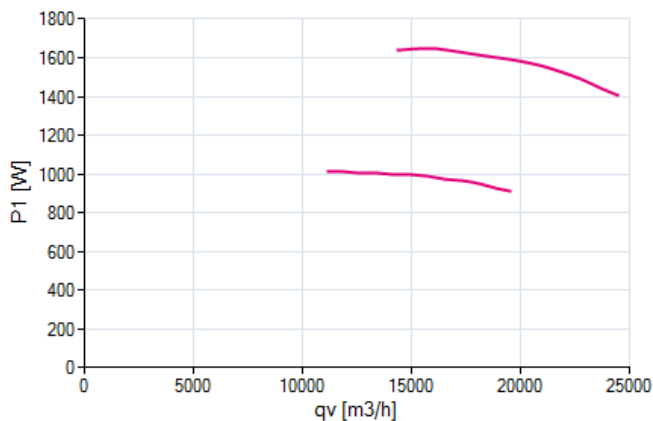



nominal values

25.11.2024

version FANselect V 1.01 (241125), AMCA V 1.03 September, 2021
RLT V 1.00 Dezember, 2021 / 1.24.11.25 | 30813 | (user ZAFS20813)

1



FN080-SDQ.6N.V7
154474

3~ 400V +10/-10 D/Y 50Hz P1 1.60/1.0kW P2 1.25/0.58kW
3.60/1.80A DI=0% 870/670/MIN COSY 0.66 70°C
3~ 400V +10/-10 D/Y 60Hz P1 2.30/1.15kW P2 1.55/0.50kW
4.10/2.00A DI=0% 930/640/MIN COSY 0.78 60°C
3~ 460V +10/-10 D/Y 60Hz P1 2.50/1.4kW P2 1.85/0.69kW
4.20/2.20A DI=0% 990/710/MIN COSY 0.75 55°C
IP54 THCL155

drawing

25.11.2024

version FANselect V 1.01 (241125), AMCA V 1.03 September, 2021
RLT V 1.00 Dezember, 2021 / 1.24.11.25 | 30813 | (user ZAFS20813)

1



FN080-SDQ.6N.V7
154474

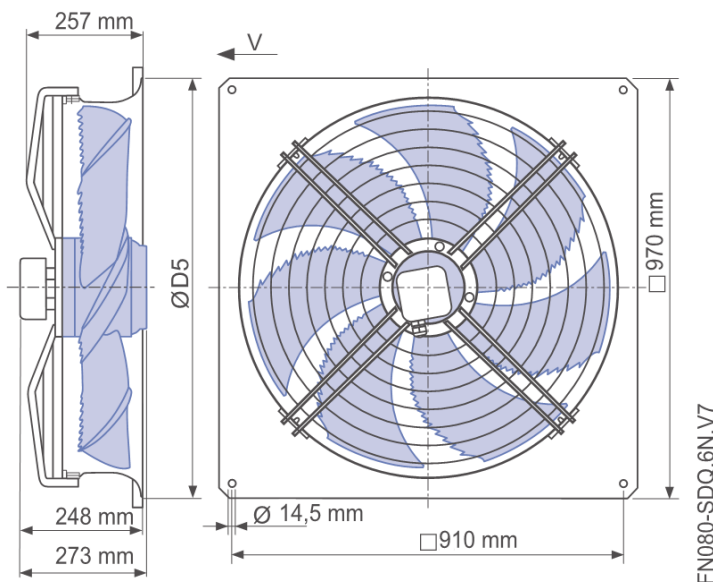

wiring diagram

25.11.2024

version FANselect V 1.01 (241125), AMCA V 1.03 September, 2021
RLT V 1.00 Dezember, 2021 / 1.24.11.25 | 30813 | (user ZAFS20813)

1



FN080-SDQ.6N.V7
154474

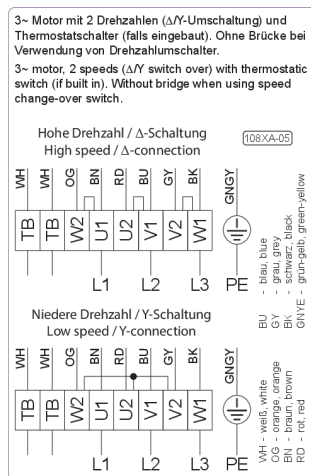

FANselect



system components

25.11.2024

Version FANselect V 1.01 (241125), AMCA V 1.03 September, 2021
RLT V 1.00 Dezember, 2021 / 1.24.11.25 | 30813 | (user ZAFS20813)



type	FN080-SDQ.6N.V7
article no.	154474